

Common Rail Spare Parts

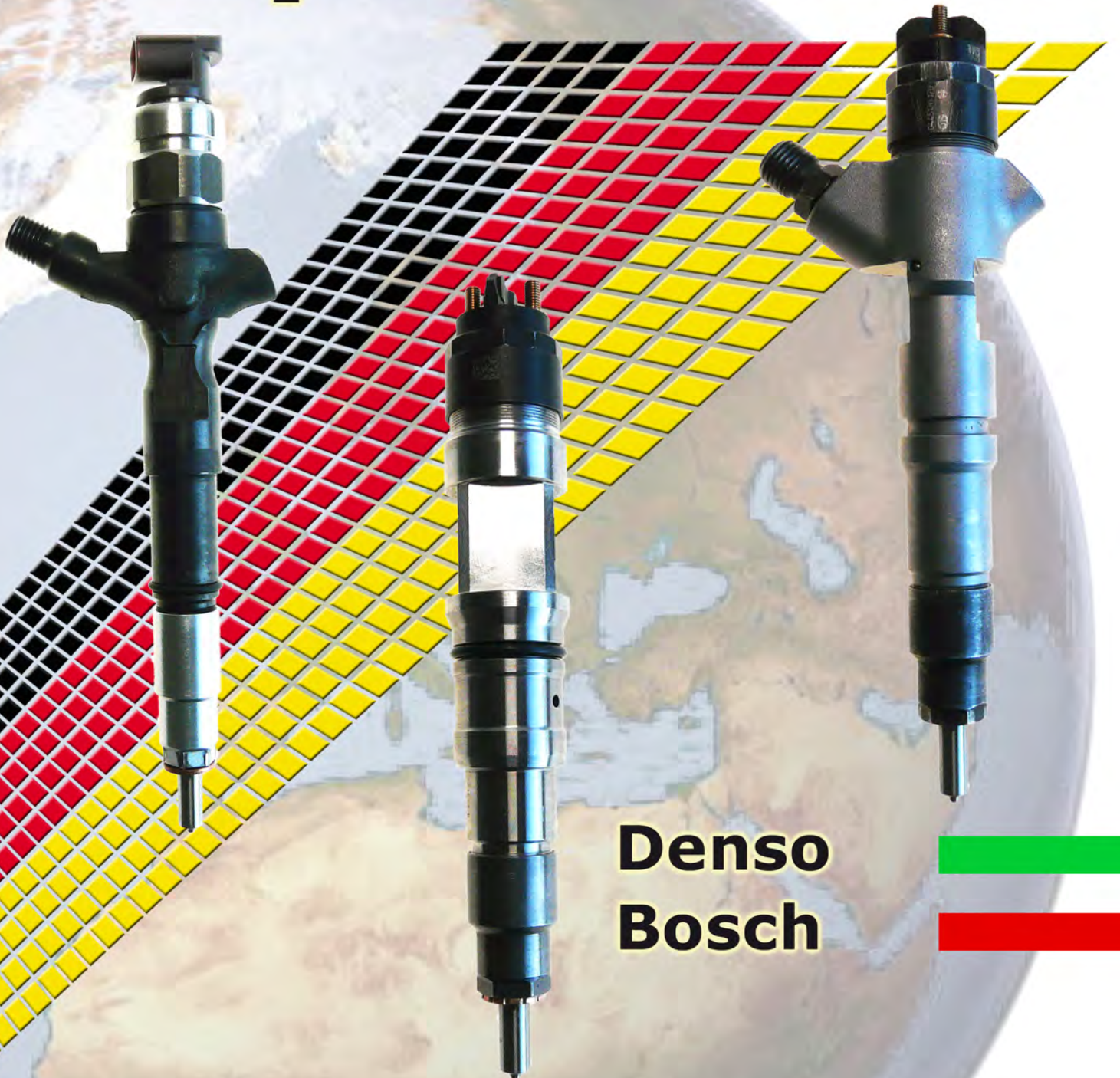

Denso
Bosch

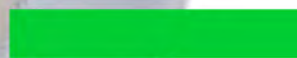



Qualitätsmanagement

Wir sind zertifiziert

Regelmäßige freiwillige
Überwachung nach ISO 9001:2008



Wichtige Hinweise:

Im Geschäftsverkehr, zwischen uns und unseren Kunden gelten für die Dauer der Geschäftsverbindungen, also auch für künftige Aufträge, ausschließlich unsere Allgemeinen Geschäftsbedingungen (AGB). Sie finden die ausführlichen Vertragsbedingungen unter www.portex.de oder wir schicken Sie Ihnen gern zu.

Inhalte und Darstellung der Kataloge (gedruckt, CD und online) sind urheberrechtlich geschützt und Eigentum von Portex. Alle Rechte vorbehalten. Nachdruck – auch auszugsweise – bedarf besonderer Genehmigung

Mit diesem Katalog verlieren alle vorherigen Kataloge ihre Gültigkeit. Irrtum und Produktänderung vorbehalten.

Teile-Nummern anderer Hersteller sind ausschließlich zu Vergleichszwecken aufgeführt.

Important informations:

Our General Terms of Sale and Delivery are valid for all business contacts between ourselves and our customers, including future contracts. Please find our detailed terms of the contract below: www.portex.de or we would be pleased to send it.

Contents and representation of catalogues (printed, CD and online) are subject of the copyright of Portex. All rights reserved. This prospectus, or any part thereof, may not be reproduced without our permission.

With this catalogue all previous catalogues lose their validity. Mistakes and changes of products reserve.

Part numbers of other manufacturers are only mentioned for comparison purposes.

Denso High Pressure Pumps

Repairkit for HP 2 Reference 097 490-0010 - with oil seal

FLAG 80 1602

For passenger cars and light-duty-vehicles



- 1. 81 0116
- 2. 81 0197
- 3. 81 0566
- 4. 81 0648
- 5. 81 0854
- 6. 81 0895
- 7. 81 0896
- 8. 81 1143
- 9. 82 0539
- 10. 83 0311
- 11. 84 0014
- 12. 84 0274

Repairkit for HP 3 Reference 294 009-0080 - without oil seal

FLAG 80 1601

For medium-duty-vehicles



- 1. 81 0081
- 2. 81 0083
- 3. 81 1610
- 4. 81 0381
- 5. 81 0645
- 6. 81 1450
- 7. 81 0943
- 8. 81 1615
- 9. 83 0686

Repairkit for HP 3 Reference 294 009-0080 - with oil seal

FLAG 80 1606

For medium-duty-vehicles



- 1. 81 0081
- 2. 81 0083
- 3. 81 1610
- 4. 81 0381
- 5. 81 0645
- 6. 81 1450
- 7. 81 0143
- 8. 81 1615
- 9. 83 0686
- 10. 81 1418

Denso High Pressure Pumps

Repairkit for HP 3 Reference 294 009-0030 - without oil seal

FLAG 80 1600

For medium-duty-vehicles

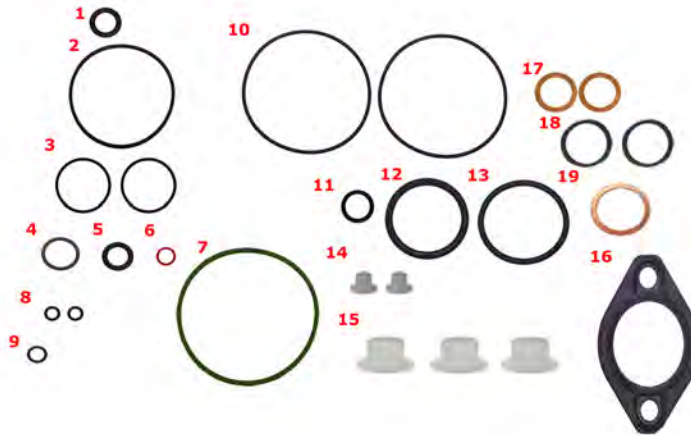

1. 81 0013
2. 81 0028
3. 81 0083
4. 81 1618
5. 81 0196
6. 81 0381
7. 81 0645
8. 81 1449
9. 81 1610
10. 81 1615
11. 81 0116
12. 81 1624
13. 81 1632
14. 83 0005
15. 83 0006
16. 83 0686
17. 84 0144
18. 84 0167
19. 84 0178

Repairkit for HP 3 Reference 294 009-0030 - with oil seal

FLAG 80 1605

For medium-duty-vehicles



1. 81 0013
2. 81 0028
3. 81 0083
4. 81 1618
5. 81 0196
6. 81 0381
7. 81 0645
8. 81 1449
9. 81 1610
10. 81 1615
11. 81 0116
12. 81 1624
13. 81 1632
14. 81 1418
15. 83 0005
16. 83 0006
17. 83 0686
18. 84 0144
19. 84 0178
20. 84 0167

Denso High Pressure Pumps

Repairkit for HP 3 Reference 294 009-0110 - without oil seal

FLAG 80 1603

For medium-duty-vehicles



1. 81 0013
2. 81 0010
3. 81 0083
4. 81 1618
5. 81 1247
6. 81 0381
7. 81 0645
8. 81 1449
9. 81 1610
10. 81 1615
11. 81 0116
12. 81 1624
13. 81 1632
14. 83 0005
15. 83 0006
16. 83 0686
17. 83 0007
18. 84 0167
19. 83 0051
20. 84 0003

Repairkit for HP 3 Reference 294 009-0110 - with oil seal

FLAG 80 1607

For medium-duty-vehicles



1. 81 0013
2. 81 0010
3. 81 0083
4. 81 1618
5. 81 1247
6. 81 0381
7. 81 0645
8. 81 1449
9. 81 1610
10. 81 1615
11. 81 0116
12. 81 1624
13. 81 1632
14. 81 1418
15. 83 0005
16. 83 0006
17. 83 0007
18. 83 0051
19. 83 0686
20. 84 0003
21. 84 0167

Denso High Pressure Pumps

Repairkit for HP 4 Reference 294 009-0050 / 294 009-0051

FLAG 80 1604

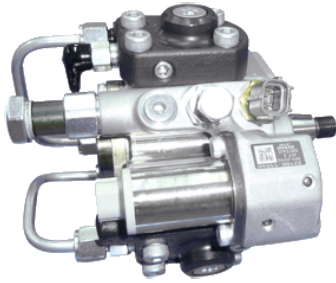

- 1. 81 0013
- 2. 81 0403
- 3. 81 0083
- 4. 81 1618
- 5. 81 0381
- 6. 81 0588
- 7. 81 0648
- 8. 81 1615
- 9. 81 0116
- 10. 81 1374
- 11. 81 1449
- 12. 81 1632
- 13. 83 0005
- 14. 83 0006
- 15. 83 0008
- 16. 83 0012
- 17. 83 0029
- 18. 83 0686
- 19. 84 0003
- 20. 84 0144
- 21. 84 0167

Denso Common Rail

1. Generation

Denso 095000-0941/095000-942/095000-077# Toyota Tiger

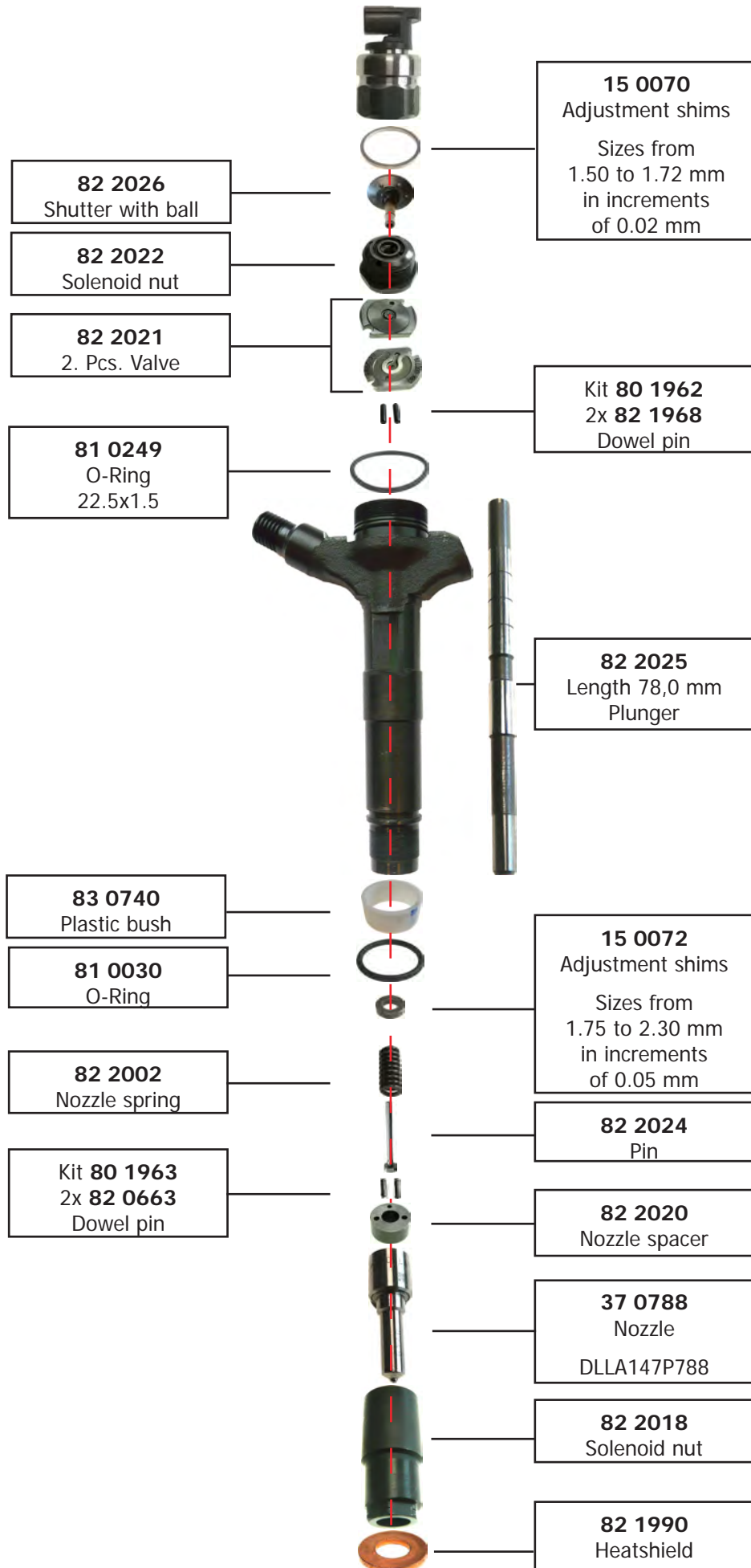

Denso Common Rail

2. Generation

Denso 095000-625 Nissan Navara YD 25

Denso 095000-776 Toyota Hilux

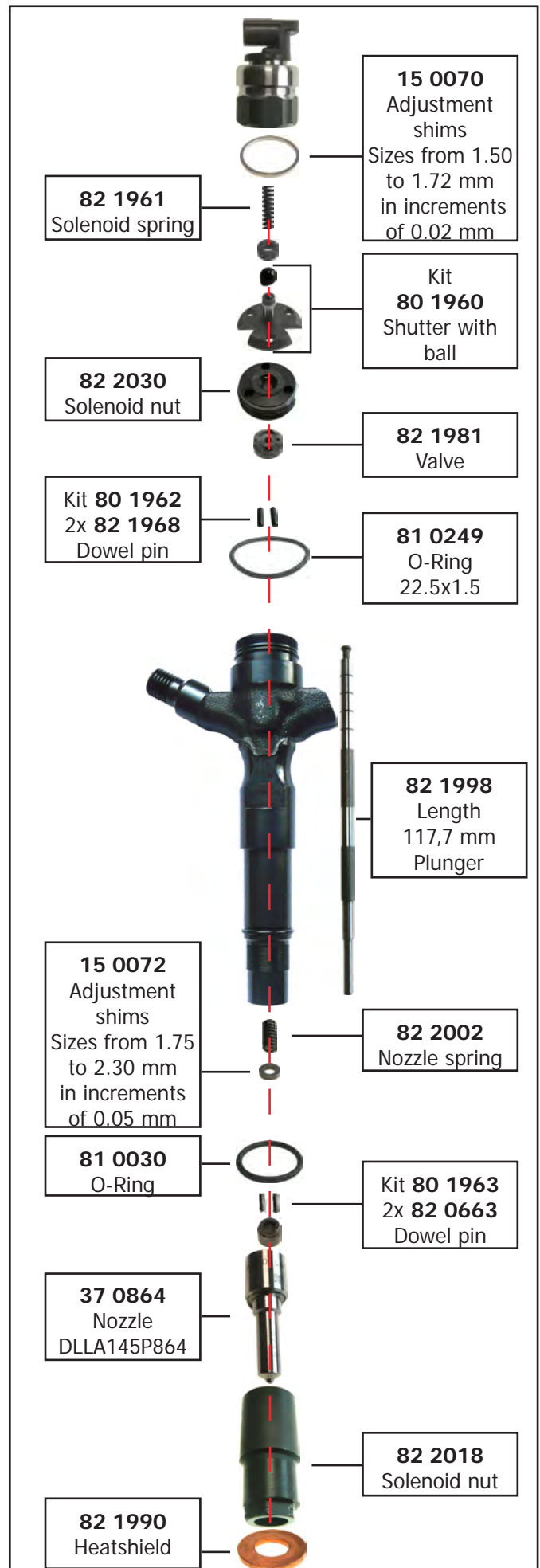
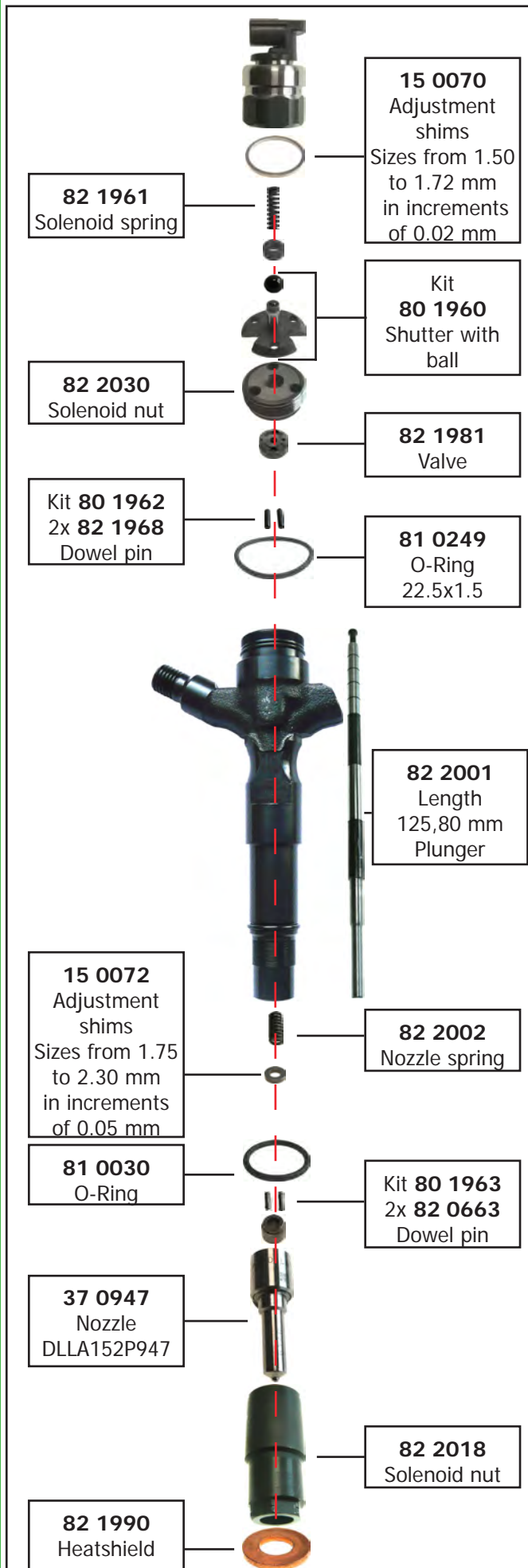

Denso Common Rail

2. Generation

Denso 095000-547 Isuzu N-Series

Denso 095000-560 Mitsubishi Triton

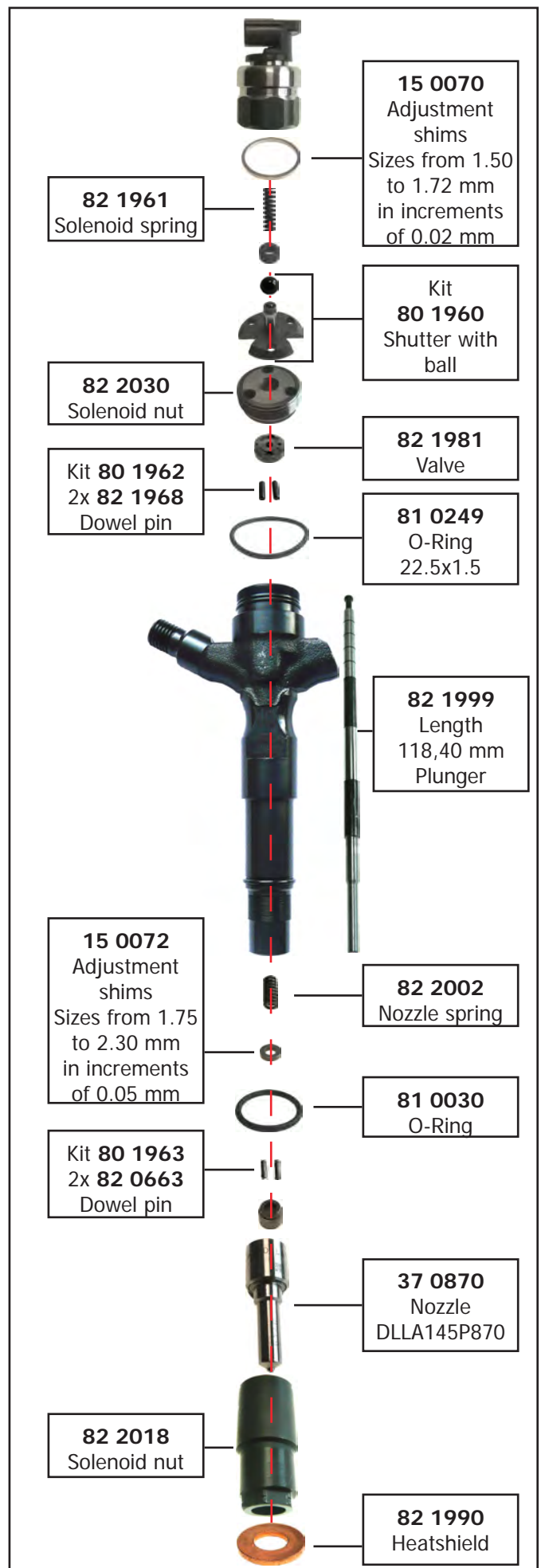
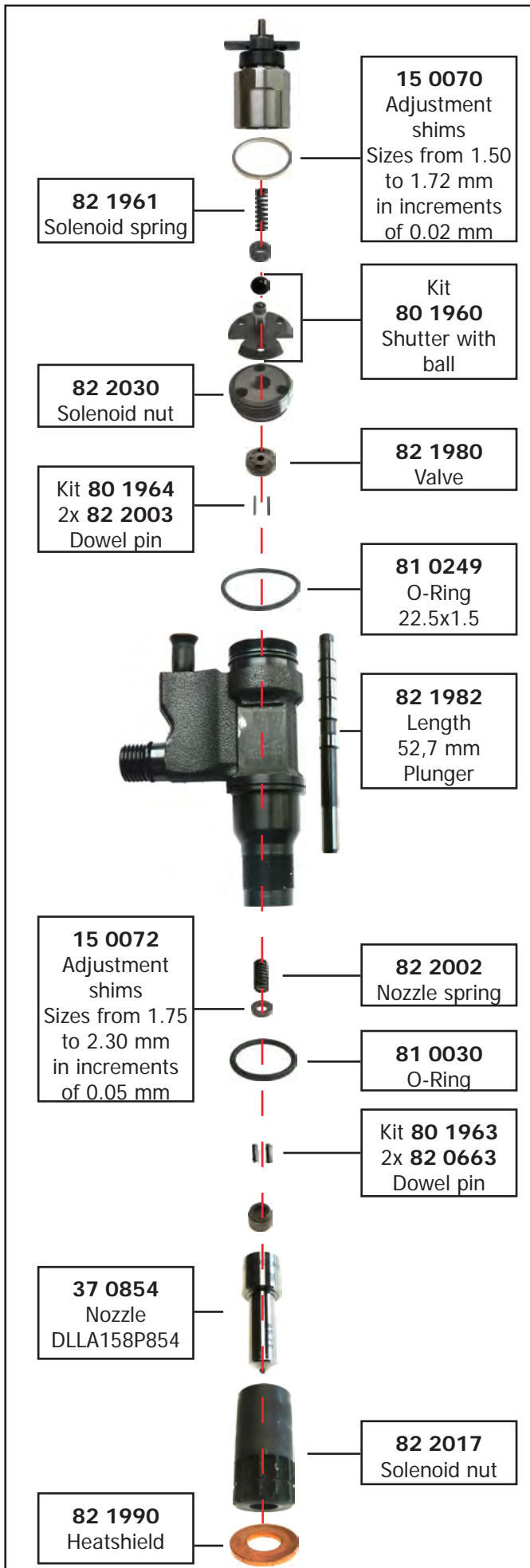

Denso Common Rail Kits

Repairkit for Denso 095000-547 Isuzu N-Series

FLAG 80 1967



Length
52,7 mm



1. 82 1980
Valve
2. 82 2030
Solenoid nut
3. 82 1965
Solenoid anchor
4. 82 1966
Half ball ceramic
5. 82 1982
Plunger

Repairkit for Denso 095000-560 Mitsubishi Triton

FLAG 80 1968



Length
118,40 mm



1. 82 1981
Valve
2. 82 2030
Solenoid nut
3. 82 1965
Solenoid anchor
4. 82 1966
Half ball ceramic
5. 82 1999
Plunger

Repairkit for Denso 095000-625 Nissan Navara

FLAG 80 1969



Length
125,80 mm



1. 82 1981
Valve
2. 82 2030
Solenoid nut
3. 82 1965
Solenoid anchor
4. 82 1966
Half ball ceramic
5. 82 2001
Plunger

Repairkit for Denso 095000-776 Toyota Hilux

FLAG 80 1966



Length
117,7 mm



1. 82 1981
Valve
2. 82 2030
Solenoid nut
3. 82 1965
Solenoid anchor
4. 82 1966
Half ball ceramic
5. 82 1998
Plunger

Repairkit for Denso 095000-0941/095000-942/095000-077# Toyota Tiger

FLAG 80 1965























Length
78,0 mm



1. 82 1966
Half ball ceramic
2. 82 2021
Valve
3. 82 2026
Shutter with ball
4. 82 2022
Solenoid nut
5. 82 2025
Plunger

Denso Common Rail

15 0070 - Adjustment shims box set for Denso Common Rail					
 82 3320 21.50x24.20x1.50 10 pieces		 82 3321 21.50x24.20x1.52 10 pieces		 82 3322 21.50x24.20x1.54 10 pieces	
 82 3323 21.50x24.20x1.56 10 pieces		 82 3324 21.50x24.20x1.58 10 pieces		 82 3325 21.50x24.20x1.60 10 pieces	
 82 3326 21.50x24.20x1.62 10 pieces		 82 3327 21.50x24.20x1.64 10 pieces		 82 3328 21.50x24.20x1.66 10 pieces	
 82 3329 21.50x24.20x1.68 10 pieces		 82 3330 21.50x24.20x1.70 10 pieces		 82 3331 21.50x24.20x1.72 10 pieces	



FLAG 15 0070
Adjustment shims box set
2 PIN Injector

12 different sizes
Total 120 pieces

shims size from
1.50 to 1.72 mm
in increments of 0.02 mm

Application
mm.24, 30x21, 50
for injectors
common rail Denso

15 0071 - Adjustment shims box set for Denso Common Rail					
 82 3340 20.00x23.20x2.99 10 pieces		 82 3341 20.00x23.20x3.00 10 pieces		 82 3342 20.00x23.20x3.01 10 pieces	
 82 3343 20.00x23.20x3.02 10 pieces		 82 3344 20.00x23.20x3.03 10 pieces		 82 3345 20.00x23.20x3.04 10 pieces	
 82 3346 20.00x23.20x3.05 10 pieces		 82 3347 20.00x23.20x3.06 10 pieces		 82 3348 20.00x23.20x3.07 10 pieces	
 82 3349 20.00x23.20x3.08 10 pieces		 82 3350 20.00x23.20x3.09 10 pieces		 82 3351 20.00x23.20x3.10 10 pieces	























FLAG 15 0071
Adjustment shims box set
4 PIN Injector

12 different sizes
Total 120 pieces

shims size from
2.99 to 3.10 mm
in increments of 0.01 mm

Application
EXAGONAL
mm.23, 20x20, 00
for injectors
common rail Denso

15 0072 - Adjustment shims box set for Denso Common Rail					
 82 3360 3.50x5.39x1.75 10 pieces		 82 3361 3.50x5.39x1.80 10 pieces		 82 3362 3.50x5.39x1.85 10 pieces	
 82 3363 3.50x5.39x1.90 10 pieces		 82 3364 3.50x5.39x1.95 10 pieces		 82 3365 3.50x5.39x2.00 10 pieces	
 82 3366 3.50x5.39x2.05 10 pieces		 82 3367 3.50x5.39x2.10 10 pieces		 82 3368 3.50x5.39x2.15 10 pieces	
 82 3369 3.50x5.39x2.20 10 pieces		 82 3370 3.50x5.39x2.25 10 pieces		 82 3371 3.50x5.39x2.30 10 pieces	



FLAG 15 0072
Adjustment shims box set
2 PIN Injector

12 different sizes
Total 120 pieces

shims size from
1.75 to 2.30 mm
in increments of 0.05 mm

Application
mm.6, 75x3, 50
for injectors
common rail Denso

Denso Common Rail



All Denso-Nozzles are with coated needle

Nozzles

FLAG	Type-Formula	Reference	Application
37 0842	DLLA155P842	093400-8420	Hino Truck
37 0844	DLLA158P844	093400-8440	Isuzu Forward
37 0848	DLLA155P848	093400-8480	Isuzu N-Series - Kobelco
37 0854	DLLA158P854	093400-8540	Isuzu N-Series
37 0863	DLLA155P863	093400-8630	Toyota Hiace/Hilux/Landcruiser
37 0865	DLLA152P865	093400-8650	Isuzu N-Series
37 0870	DLLA145P870	093400-8700	Mitsubishi L2004
37 0880	DLLA155P880	093400-8800	Toyota Hilux
37 0872	DLLA148P872	093400-8720	Nissan Navara/Pathfinder
37 0941	DLLA155P941	093400-9410	Toyota Dyna/Hino
37 1024	DLLA145P1024	093400-1024	Toyota Hiace/Hilux/Landcruiser
37 0864	DLLA145P864	093400-8640	Toyota Hilux
37 0852	DLLA142P852	093400-8520	
37 0885	DLLA155P885	093400-8850	
37 0947	DLLA152P947	093400-9470	Nissan Navara



Heatshields

FLAG	Reference
82 1985	11176-26010
82 1986	11176-26020
82 1987	11176-26030
82 1988	11176-27010
82 1989	11176-30010
82 1990	11176-30011

Bosch Common Rail



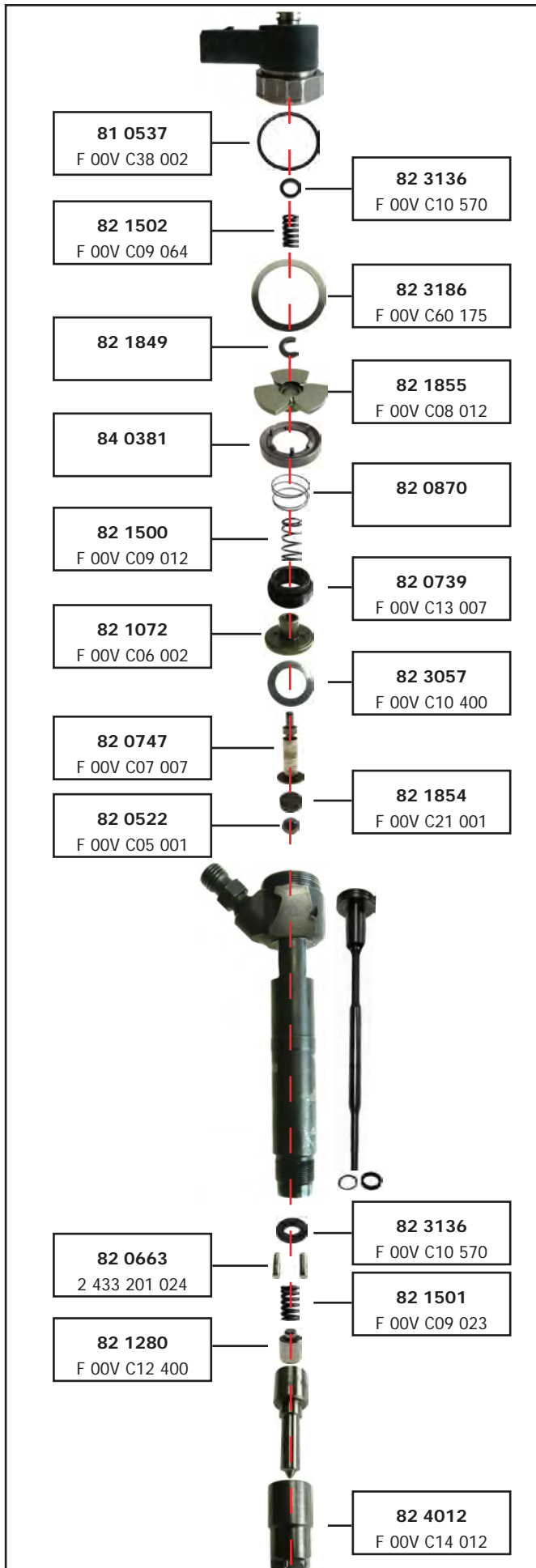

1. Generation

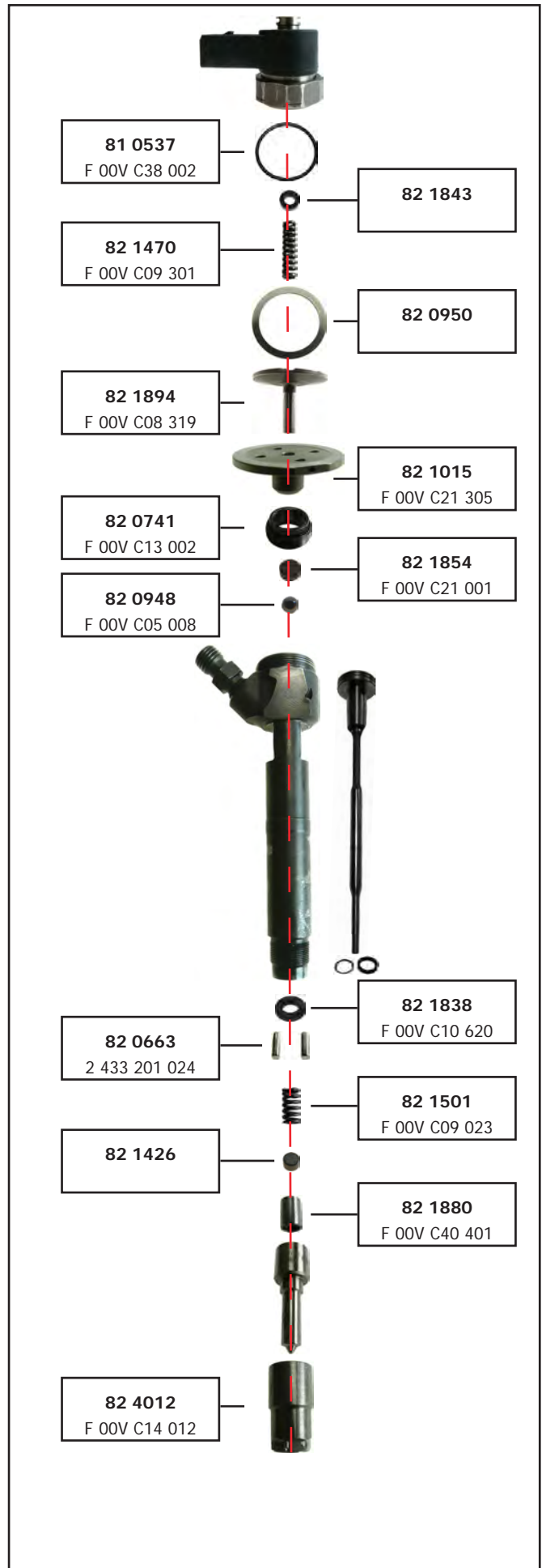

2. Generation



Bosch Common Rail

		 Valve Set		 Seal Kit		 Nozzle		 Magnet	
FLAG	Reference	FLAG	Reference	FLAG	Reference	FLAG	Reference	FLAG	Reference
15 5002	0 445 110 002	82 1930	F 00V C01 016	80 1198	F 00V C99 002	37 5175	0 433 175 175	12 0310	F 00V C30 055
15 5011	0 445 110 011	82 1361	F 00V C01 001	80 1198	F 00V C99 002	37 5163	0 433 175 163	12 0300	F 00V C30 054
15 5014	0 445 110 014	82 1361	F 00V C01 001	80 1198	F 00V C99 002	37 5164	0 433 175 164	12 0330	F 00V C30 053
15 5024	0 445 110 024	82 1361	F 00V C01 001	80 1198	F 00V C99 002	37 5163	0 433 175 163	13 0300	F 00V C30 054
15 5034	0 445 110 034	82 1361	F 00V C01 001	80 1198	F 00V C99 002	37 1594	0 433 171 594	13 0300	F 00V C30 054
15 5038	0 445 110 038	82 2040	F 00V C01 011	80 1198	F 00V C99 002	37 5253	0 433 175 253	12 0312	F 00V C30 058
15 5047	0 445 110 047	82 2041	F 00V C01 043	80 1198	F 00V C99 002	37 1616	0 433 171 616	12 0311	F 00V C30 057
15 5048	0 445 110 048	82 2041	F 00V C01 043	80 1198	F 00V C99 002	37 1617	0 433 171 617	12 0311	F 00V C30 057
15 5054	0 445 110 054	82 1357	F 00V C01 309	80 1198	F 00V C99 002	37 5314	0 433 175 314	12 0301	F 00V C30 326
15 5063	0 445 110 063	82 2040	F 00V C01 011	80 1198	F 00V C99 002	37 5278	0 433 175 278	12 0312	F 00V C30 058
15 5064	0 445 110 064	82 1339	F 00V C01 044	80 1198	F 00V C99 002	37 1654	0 433 171 654	12 0311	F 00V C30 057
15 5069	0 445 110 069	82 1361	F 00V C01 001	80 1198	F 00V C99 002	37 5298	0 433 175 298	12 0300	F 00V C30 054
15 5071	0 445 110 071	82 1361	F 00V C01 001	80 1198	F 00V C99 002	37 5163	0 433 175 163	12 0300	F 00V C30 054
15 5076	0 445 110 076	82 1933	F 00V C01 053	80 1198	F 00V C99 002	37 5431	0 433 175 431	12 0311	F 00V C30 057
15 5083	0 445 110 083	82 2042	F 00V C01 038	80 1198	F 00V C99 002	37 1774	0 433 171 774	12 0316	F 00V C30 316
15 5084	0 445 110 084	82 2043	F 00V C01 022	80 1198	F 00V C99 002	37 1695	0 433 171 695	12 0312	F 00V C30 058
15 5087	0 445 110 087	82 2043	F 00V C01 022	80 1198	F 00V C99 002	37 5318	0 433 175 318	12 0312	F 00V C30 058
15 5095	0 445 110 095	82 1331	F 00V C01 045	80 1198	F 00V C99 002	37 1712	0 433 171 712	12 0300	F 00V C30 054
15 5099	0 445 110 099	82 1331	F 00V C01 045	80 1198	F 00V C99 002	37 5326	0 433 175 326	12 0300	F 00V C30 054
15 5101	0 445 110 101	82 1339	F 00V C01 044	80 1198	F 00V C99 002	37 1921	0 433 171 654	12 0311	F 00V C30 057
15 5105	0 445 110 105	82 1331	F 00V C01 045	80 1198	F 00V C99 002	37 5395	0 433 175 395	12 0300	F 00V C30 054
15 5107	0 445 110 107	82 1331	F 00V C01 045	80 1198	F 00V C99 002	37 5395	0 433 175 395	12 0300	F 00V C30 054
15 5115	0 445 110 115	82 1321	F 00V C01 024	80 1198	F 00V C99 002	37 5342	0 433 175 342	12 0330	F 00V C30 053
15 5120	0 445 110 120	82 1331	F 00V C01 045	80 1198	F 00V C99 002	37 1712	0 433 171 712	12 0300	F 00V C30 054
15 5131	0 445 110 131	82 2044	F 00V C01 310	80 1198	F 00V C99 002	37 1690	0 433 171 696	12 0325	F 00V C30 325
15 5155	0 445 110 155	82 1364	F 00V C01 328	80 1198	F 00V C99 002	37 1800	0 433 171 800	12 0301	F 00V C30 326
15 5176	0 445 110 176	82 1364	F 00V C01 328	80 1198	F 00V C99 002	37 1800	0 433 171 800	12 0301	F 00V C30 326
15 5183	0 445 110 183	82 2045	F 00V C01 334	80 1198	F 00V C99 002	37 1889	0 433 171 889	12 0303	F 00V C30 318
15 5190	0 445 110 189	82 1338	F 00V C01 051	80 1198	F 00V C99 002	37 5395	0 433 175 395	12 0300	F 00V C30 054
15 5201	0 445 110 201	82 1338	F 00V C01 051	80 1198	F 00V C99 002	37 1712	0 433 171 712	12 0300	F 00V C30 054
15 5205	0 445 110 205	82 1338	F 00V C01 051	80 1198	F 00V C99 002	37 1913	0 433 171 913	12 0300	F 00V C30 054
15 5239	0 445 110 239	82 1355	F 00V C01 315	80 1198	F 00V C99 002	37 1914	0 433 171 914	12 0302	F 00V C30 307
15 5250	0 445 110 250	82 2095	F 00V C01 349	80 1198	F 00V C99 002	37 1921	0 433 171 921	12 0318	F 00V C30 308
15 5253	0 445 110 253	82 2046	F 00V C01 346	80 1198	F 00V C99 002	37 1933	0 433 171 933	12 0319	F 00V C30 319
15 5254	0 445 110 254	82 2046	F 00V C01 346	80 1198	F 00V C99 002	37 1933	0 433 171 933	12 0319	F 00V C30 319
15 5255	0 445 110 255	82 2048	F 00V C01 347	80 1198	F 00V C99 002	37 1931	0 433 171 931	12 0303	F 00V C30 318
15 5257	0 445 110 257	82 2046	F 00V C01 346	80 1198	F 00V C99 002	37 1932	0 433 171 932	12 0319	F 00V C30 319
15 5258	0 445 110 258	82 2046	F 00V C01 346	80 1198	F 00V C99 002	37 1932	0 433 171 932	12 0319	F 00V C30 319
15 5269	0 445 110 269	82 2046	F 00V C01 346	80 1198	F 00V C99 002	37 1980	0 433 171 980	12 0319	F 00V C30 319
15 5270	0 445 110 270	82 2046	F 00V C01 346	80 1198	F 00V C99 002	37 1980	0 433 171 980	12 0319	F 00V C30 319
15 5279	0 445 110 279	82 1935	F 00V C01 033	80 1198	F 00V C99 002	37 1848	0 433 171 848	12 0312	F 00V C30 058
15 5301	0 445 110 301	82 2047	F 00V C01 331	80 1198	F 00V C99 002	37 2021	0 433 172 021	12 0303	F 00V C30 318

Bosch Common Rail

Typ 1

Typ 2

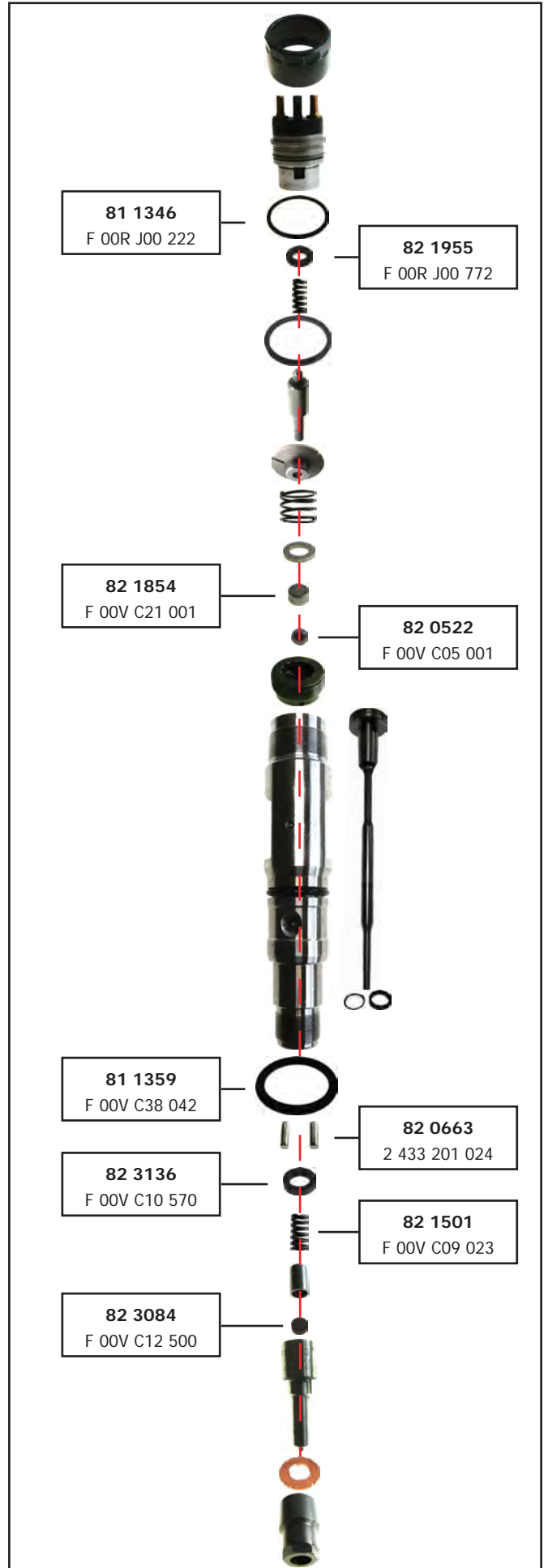
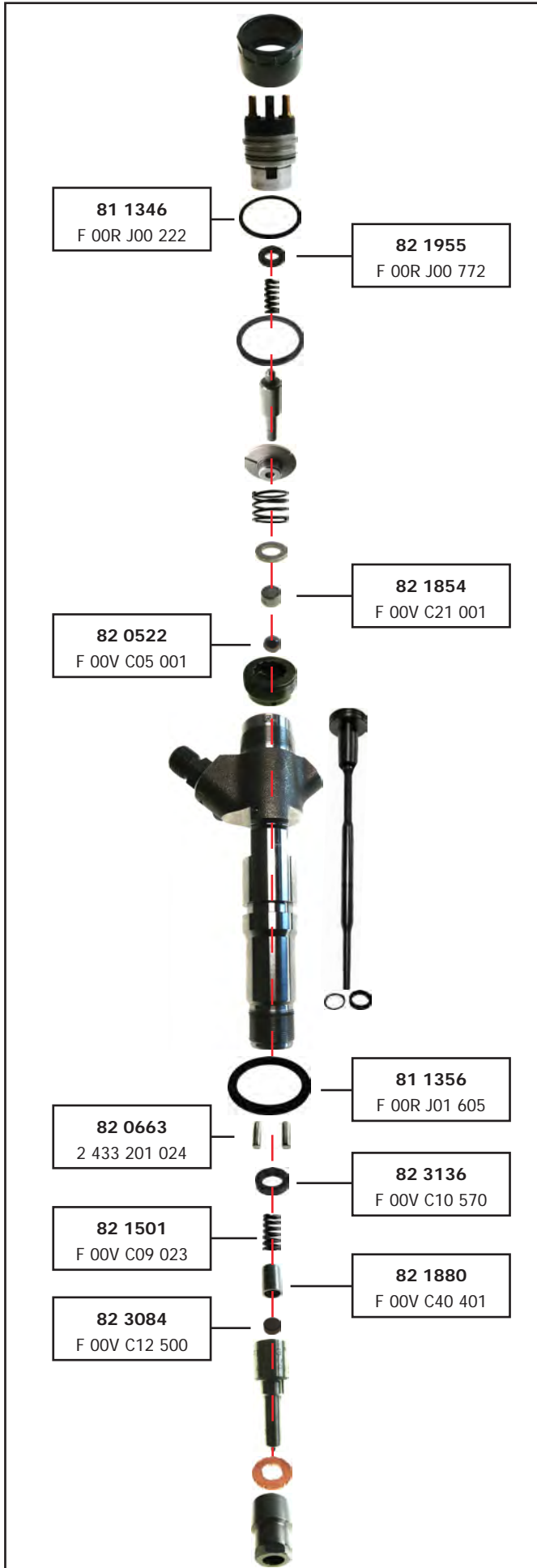



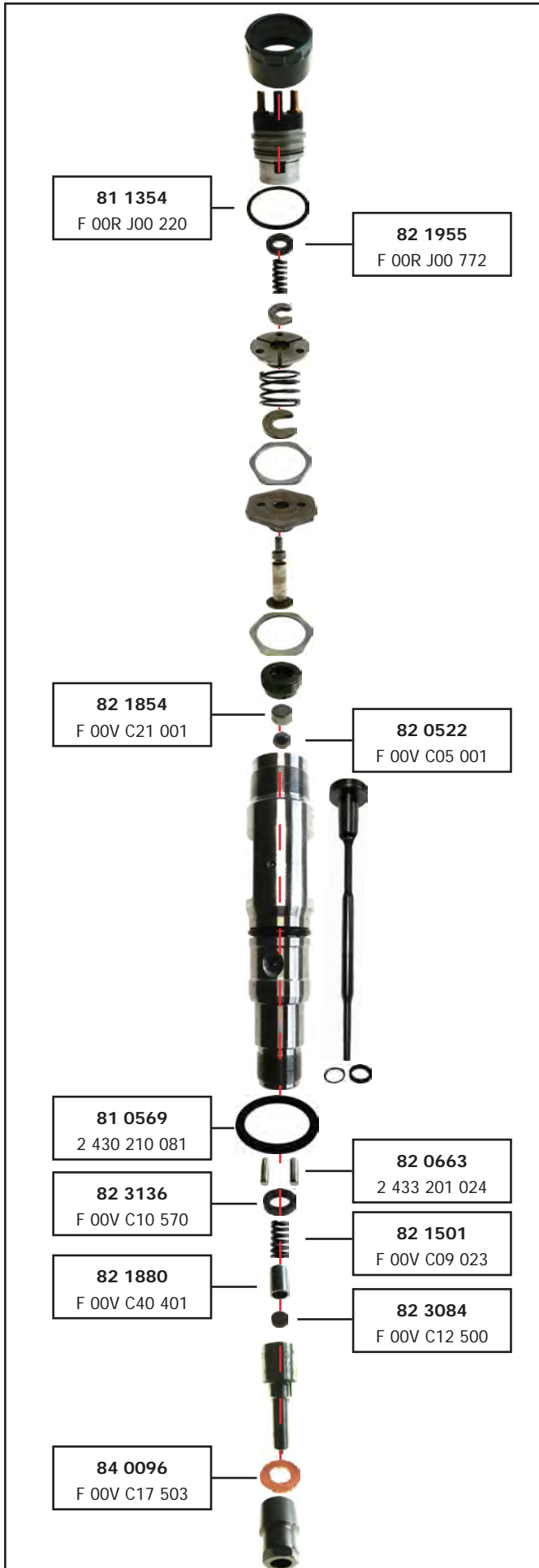

Bosch Common Rail





Typ 3



Bosch Common Rail

		 Valve Set		 Seal Kit		 Nozzle		 Support	
FLAG	Reference	FLAG	Reference	FLAG	Reference	FLAG	Reference	FLAG	Reference
15 6002	0 445 120 002	82 1991	F 00R J00 005	80 2176	F 00R J02 176	37 5203	0 433 175 203		
15 6003	0 445 120 003	82 1992	F 00R J00 218	80 2176	F 00R J02 176	37 1562	0 433 171 562	82 2053	F 00R J01 919
15 6004	0 445 120 004	82 1992	F 00R J00 218	80 2176	F 00R J02 176	37 1562	0 433 171 562	82 2053	F 00R J01 919
15 6007	0 445 120 007	82 1925	F 00R J00 339	80 2176	F 00R J02 176	37 5271	0 433 175 271	82 2052	F 00R 300 414
15 6011	0 445 120 011	82 2084	F 00R J00 420	80 2176	F 00R J02 176	37 5297	0 433 175 297		
15 6012	0 445 120 012	82 2085	F 00R J01 895	80 2176	F 00R J02 176	37 1681	0 433 171 681		
15 6014	0 445 120 014	82 1941	F 00R J00 399	80 2176	F 00R J02 176	37 1683	0 433 171 683	82 2053	F 00R J01 919
15 6016	0 445 120 016	82 2085	F 00R J01 895	80 2176	F 00R J02 176	37 1682	0 433 171 682		
15 6019	0 445 120 019	82 1941	F 00R J00 399	80 2176	F 00R J02 176	37 1699	0 433 171 699	82 2053	F 00R J01 919
15 6031	0 445 120 031	82 2086	F 00R J00 995	80 2176	F 00R J02 176	37 1814	0 433 171 814	82 1227	F 00R J01 247
15 6036	0 445 120 036	82 1993	F 00R J01 176	80 2176	F 00R J02 176	37 1855	0 433 171 855		
15 6044	0 445 120 044	82 1994	F 00R J01 159	80 2176	F 00R J02 176	37 1878	0 433 171 878	82 1227	F 00R J01 247
15 6061	0 445 120 061	82 1340	F 00R J02 466	80 2176	F 00R J02 176	37 1939	0 433 171 939	82 1237	F 00R J01 029
15 6064	0 445 120 064	82 2091	F 00R J01 451	80 2176	F 00R J02 176	37 1963	0 433 171 963	82 2057	F 00R J01 457
15 6084	0 445 120 084	82 1941	F 00R J00 399	80 2176	F 00R J02 176	37 1699	0 433 171 699	82 2058	F 00R J00 463
15 6086	0 445 120 086	82 1967	F 00R J01 727	80 2176	F 00R J02 176	37 2016	0 433 172 016	82 2055	F 00R J01 730
15 6087	0445 120 087	82 1967	F 00R J01 727	80 2176	F 00R J02 176	37 2015	0 433 172 015	82 2055	F 00R J01 730
15 6095	0 445 120 095	82 2088	F 00R J02 397	80 2176	F 00R J02 176	37 1927	0 433 171 927		
15 6110	0 445 120 110	82 1924	F 00R J02 806	80 2176	F 00R J02 176	37 2034	0 433 172 034	82 2050	F 00R J01 706
15 6121	0 445 120 121	82 1927	F 00R J01 941	80 2176	F 00R J02 176	37 1047	0 433 172 047		
15 6122	0 445 120 122	82 1927	F 00R J01 941	80 2176	F 00R J02 176	37 7045	0 433 172 045		
15 6123	0 445 120 123	82 1995	F 00R J02 130	80 2176	F 00R J02 176	37 5481	0 433 175 481	82 2054	F 00R J01 620
15 6124	0 445 120 124	82 1996	F 00R J01 657	80 2176	F 00R J02 176	37 2038	0 433 172 038	82 2062	F 00R J01 659
15 6126	0 445 120 126	82 2089	F 00R J02 266	80 2176	F 00R J02 176	37 2069	0 433 172 069		
15 6127	0 445 120 127	82 1967	F 00R J01 727	80 2176	F 00R J02 176	37 2039	0 433 172 039	82 2055	F 00R J01 730
15 6129	0 445 120 129	82 1923	F 00R J01 692	80 2176	F 00R J02 176	37 2059	0 433 172 059		
15 6131	0 445 120 131	82 2090	F 00R J02 561	80 2176	F 00R J02 176	37 2073	0 433 172 073	82 2063	F 00R J02 075
15 6136	0 445 120 136	82 2091	F 00R J01 451	80 2176	F 00R J02 176	37 1963	0 433 171 963	82 2057	F 00R J01 457
15 6137	0 445 120 137	82 2091	F 00R J01 451	80 2176	F 00R J02 176	37 1963	0 433 171 963	82 2057	F 00R J01 457
15 6138	0 445 120 138	82 2091	F 00R J01 451	80 2176	F 00R J02 176	37 1965	0 433 171 965	82 2057	F 00R J01 457
15 6139	0 445 120 139	82 2091	F 00R J01 451	80 2176	F 00R J02 176	37 1965	0 433 171 965	82 2057	F 00R J01 457
15 6147	0 445 120 147	82 2092	F 00R J01 865	80 2176	F 00R J02 176	37 2094	0 433 172 094	82 2056	F 00R J00 753
15 6148	0 445 120 148	82 2092	F 00R J01 865	80 2176	F 00R J02 176	37 2084	0 433 172 084	82 2056	F 00R J00 753
15 6155	0 445 120 155	82 2096	F 00R J02 044	80 2176	F 00R J02 176	37 2042	0 433 172 042	82 2064	F 00R J02 047
15 6156	0 445 120 156	82 1924	F 00R J02 806	80 2176	F 00R J02 176	37 2108	0 433 172 108	82 2050	F 00R J01 706
15 6160	0 445 120 160	82 1997	F 00R J02 035	80 2176	F 00R J02 176	37 2114	0 433 172 114	82 2065	F 00R J02 301
15 6162	0 445 120 162	82 2097	F 00R J02 449	80 2176	F 00R J02 176	37 2120	0 433 172 120	82 2066	F 00R J02 321
15 6163	0 445 120 163	82 1923	F 00R J01 692	80 2176	F 00R J02 176	37 7116	0 433 172 116		
15 6164	0 445 120 164	82 1924	F 00R J02 806	80 2176	F 00R J02 176	37 2115	0 433 172 115		
15 6170	0 445 120 170	82 1923	F 00R J01 692	80 2176	F 00R J02 176	37 2111	0 433 172 111		

Bosch Common Rail

		 Valve Set		 Seal Kit		 Nozzle		 Support	
FLAG	Reference	FLAG	Reference	FLAG	Reference	FLAG	Reference	FLAG	Reference
15 6186	0 445 120 186	82 2097	F 00R J02 449	80 2176	F 00R J02 176	37 2119	0 433 172 119	82 2066	F 00R J02 321
15 6197	0 445 120 197	82 2099	F 00R J02 410	80 2176	F 00R J02 176	37 2042	0 433 172 042	82 2064	F 00R J02 047
15 6200	0 445 120 200	82 1923	F 00R J01 692	80 2176	F 00R J02 176	37 2059	0 433 172 059		
15 6201	0 445 120 201	82 2093	F 00R J02 410	80 2176	F 00R J02 176	37 2157	0 433 172 157	82 2064	F 00R J02 047
15 6202	0 445 120 202	82 2093	F 00R J02 410	80 2176	F 00R J02 176	37 2158	0 433 172 158	82 2064	F 00R J02 047
15 6215	0 445 120 215	82 1997	F 00R J02 035	80 2176	F 00R J02 176	37 2166	0 433 172 166	82 2068	F 00R J02 543
15 6217	0 445 120 217	82 1340	F 00R J02 466	80 2176	F 00R J02 176	37 1939	0 433 171 939	82 1237	F 00R J01 029
15 6218	0 445 120 218	82 1340	F 00R J02 466	80 2176	F 00R J02 176	37 1831	0 433 171 831	82 1237	F 00R J01 029
15 6219	0 445 120 219	82 1340	F 00R J02 466	80 2176	F 00R J02 176	37 2004	0 433 172 004	82 1237	F 00R J01 029
15 6224	0 445 120 224	82 1923	F 00R J01 692	80 2176	F 00R J02 176	37 2111	0 433 172 111	82 2061	F 00R J01 481
15 6226	0 445 120 226	82 1923	F 00R J01 692	80 2176	F 00R J02 176	37 7116	0 433 172 116		
15 6231	0 445 120 231	82 1995	F 00R J02 130	80 2176	F 00R J02 176	37 5510	0 433 175 510	82 2054	F 00R J01 620

Bosch Common Rail

CR/CP 1S3

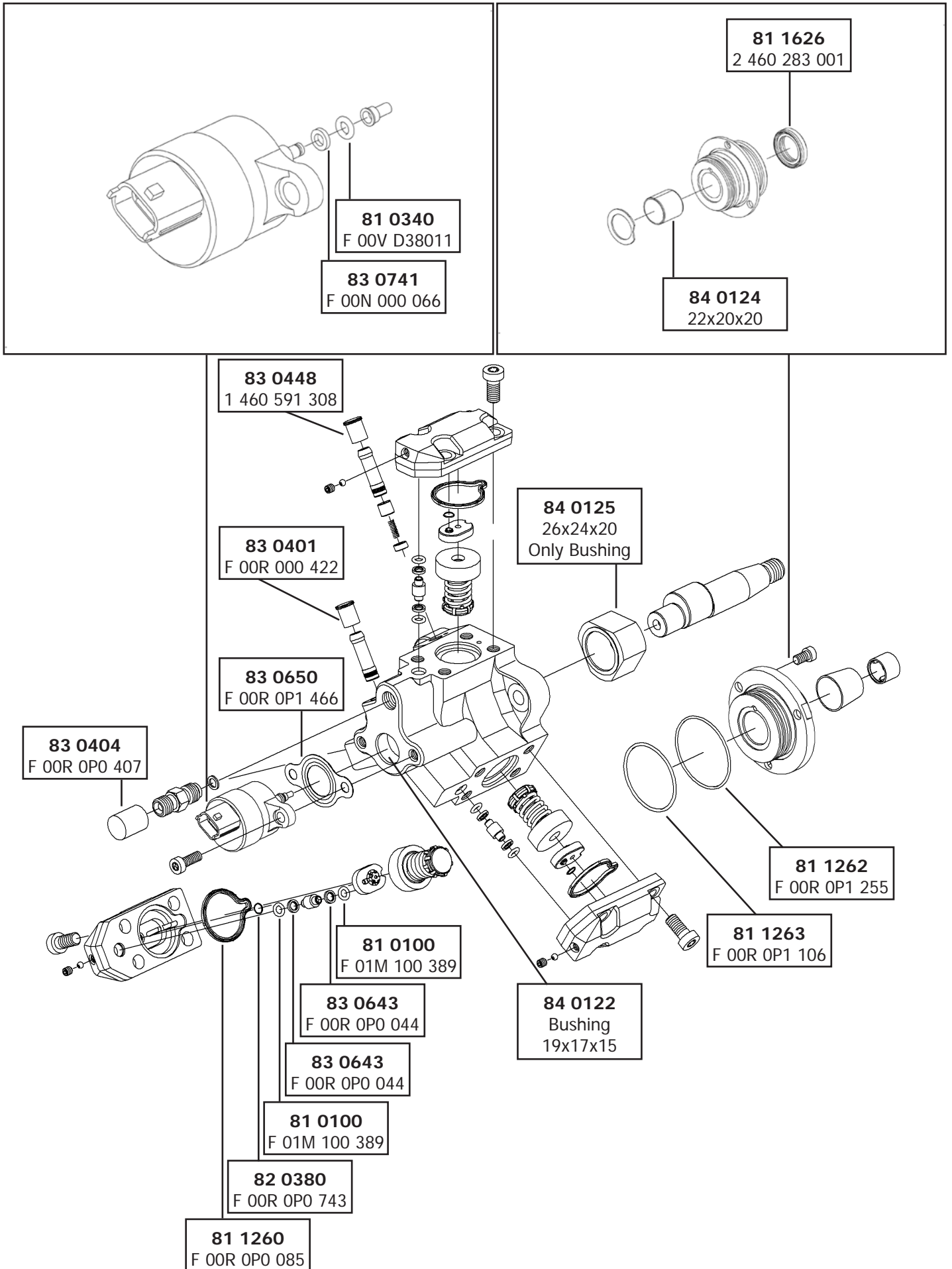

Bosch Common Rail

Repairkit for CR/CP 1 Reference CR/CP1 S..Kit

FLAG 80 1095



- 1. 81 0081
- 2. 81 0199
- 3. 81 1260
- 4. 81 1261
- 5. 81 1262
- 6. 81 1263
- 7. 81 1626
- 8. 83 0005
- 9. 83 0008
- 10. 83 0111
- 11. 83 0643
- 12. 83 0650
- 13. 83 0656
- 14. 84 0002

Repairkit for CR/CP 1 Reference F 01M 101 454

FLAG 80 1254

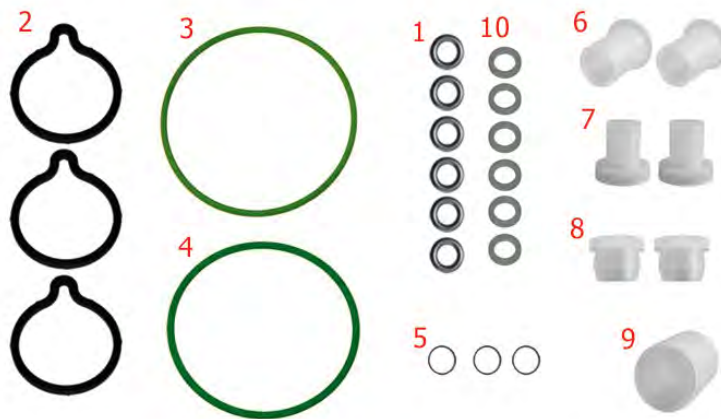

- 1. 81 0100
- 2. 81 1260
- 3. 81 1262
- 4. 81 1263
- 5. 82 0380
- 6. 83 0401
- 7. 83 0402
- 8. 83 0403
- 9. 83 0404
- 10. 83 0643

Repairkit for CR/CP 1 Reference F 01M 100 275

FLAG 80 1114

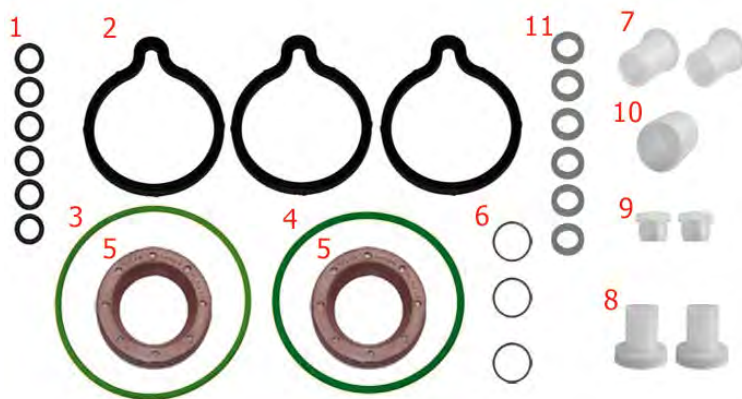

- 1. 81 0100
- 2. 81 1260
- 3. 81 1262
- 4. 81 1263
- 5. 81 1626
- 6. 82 0380
- 7. 83 0401
- 8. 83 0402
- 9. 83 0403
- 10. 83 0404
- 11. 83 0643

Repairkit for CR/CP 1 Reference CR/CP1 Bushing Kit

FLAG 80 1124



- 1. 84 0122
- 2. 84 0124
- 3. 84 0125

Bosch Common Rail

CR/CP 1K3

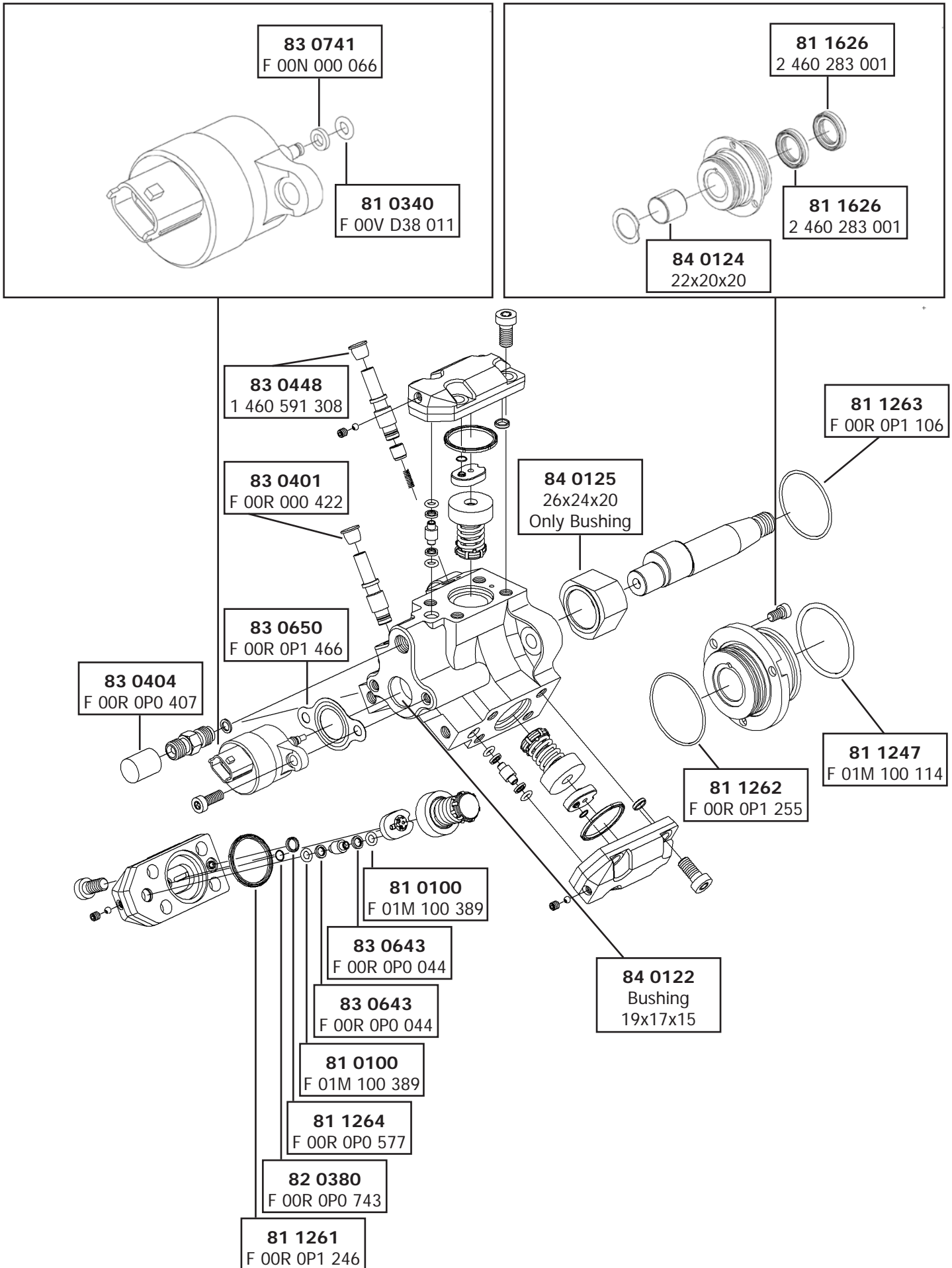

Bosch Common Rail

Repairkit for CR/CP 1 Reference F 01M 101 455

FLAG 80 1253

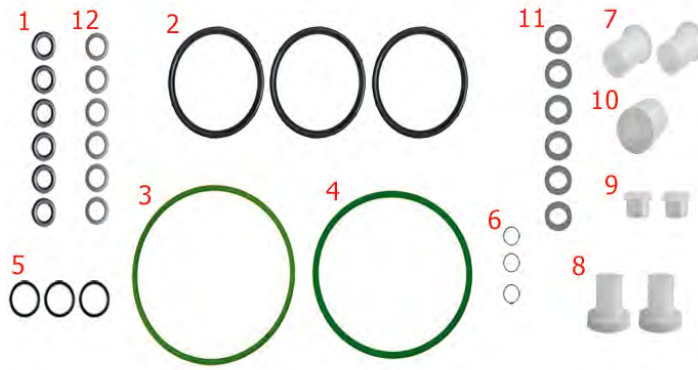

- 1. 81 0100
- 2. 81 1261
- 3. 81 1262
- 4. 81 1263
- 5. 81 1264
- 6. 82 0380
- 7. 83 0401
- 8. 83 0402
- 9. 83 0403
- 10. 83 0404
- 11. 83 0641
- 12. 83 0643

Repairkit for CR/CP 1 Reference F 01M 101 456

FLAG 80 1259

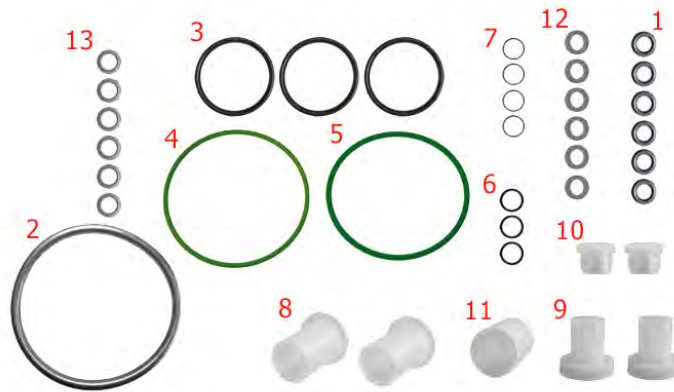

- 1. 81 0100
- 2. 81 1247
- 3. 81 1261
- 4. 81 1262
- 5. 81 1263
- 6. 81 1264
- 7. 82 0380
- 8. 83 0401
- 9. 83 0402
- 10. 83 0403
- 11. 83 0404
- 12. 83 0461
- 13. 83 0643

Repairkit for CR/CP 1 Reference F 01M 100 276

FLAG 80 1119

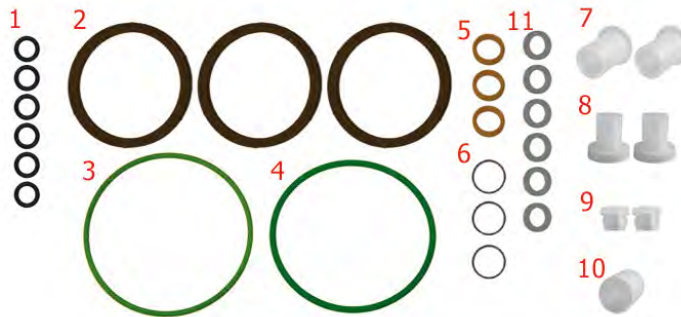

- 1. 81 0100
- 2. 81 1261
- 3. 81 1262
- 4. 81 1263
- 5. 81 1264
- 6. 82 0380
- 7. 82 0401
- 8. 83 0402
- 9. 83 0403
- 10. 83 0404
- 11. 83 0643

Repairkit for CR/CP 1 Reference F 01M 100 277

FLAG 80 1115

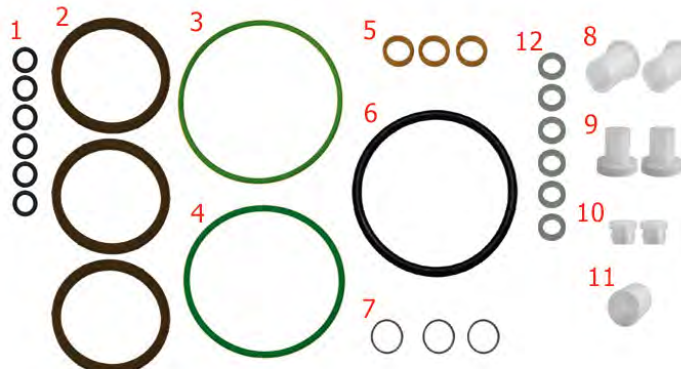

- 1. 81 0100
- 2. 81 1261
- 3. 81 1262
- 4. 81 1263
- 5. 81 1264
- 6. 81 1400
- 7. 82 0380
- 8. 83 0401
- 9. 83 0402
- 10. 83 0403
- 11. 83 0404
- 12. 83 0643

Bosch Common Rail

High Pressure Pump CR/CP 3

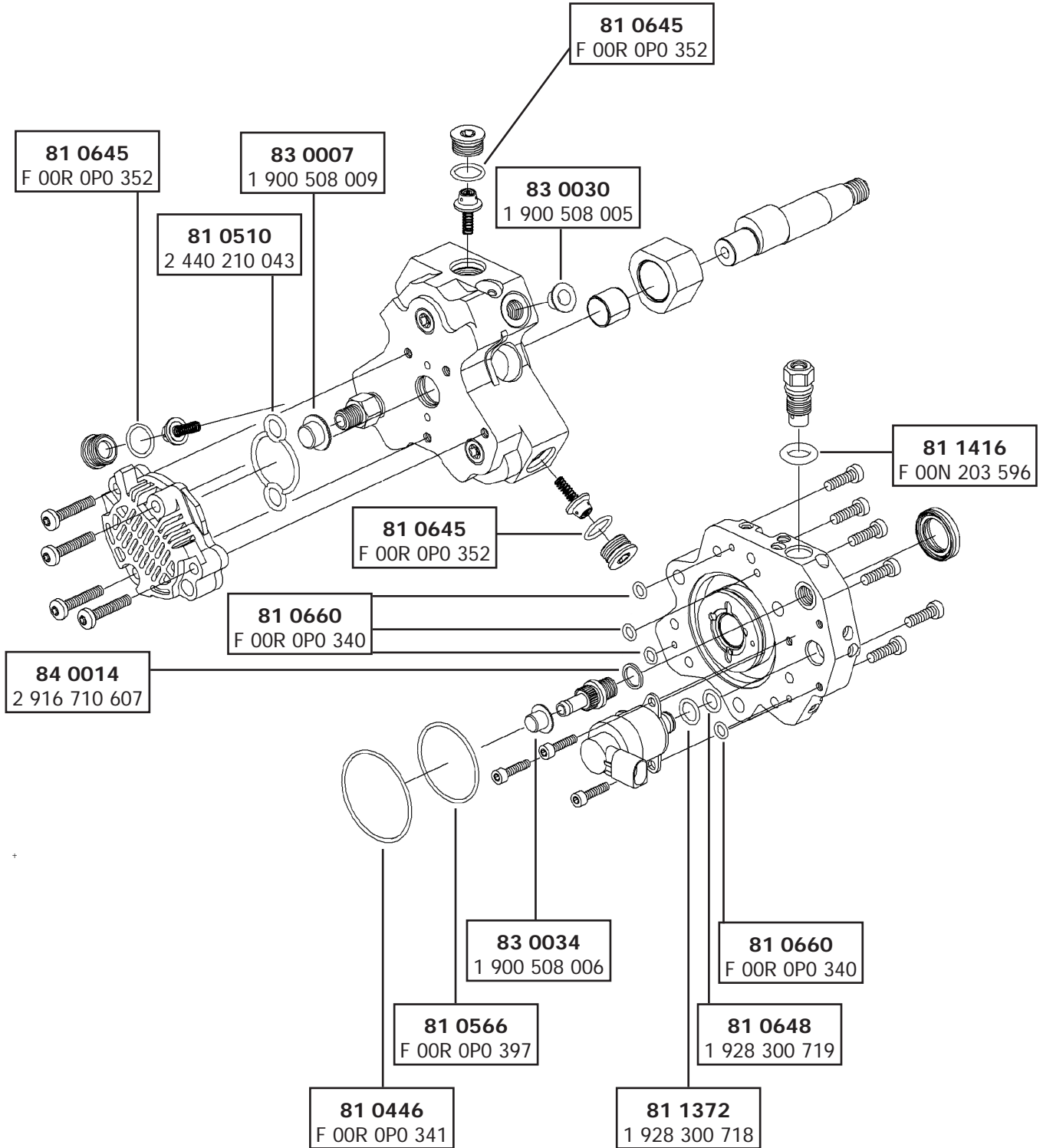

Bosch Common Rail

Repair Kit for CR/CP 3 Reference F 00N 201 974

FLAG 80 1209

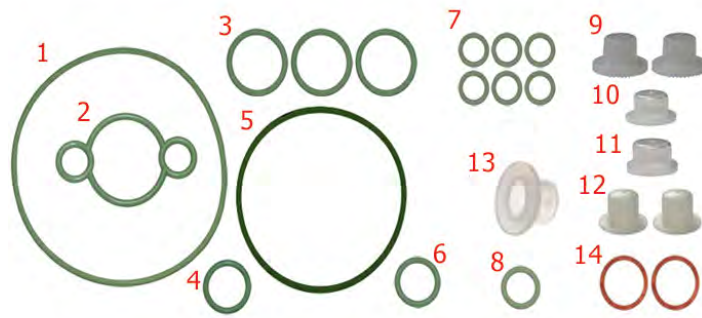

1. 81 0446
2. 81 0510
3. 81 0566
4. 81 0641
5. 81 0645
6. 81 0648
7. 81 0660
8. 81 0710
9. 83 0005
10. 83 0007
11. 83 0008
12. 83 0030
13. 83 0034
14. 84 0014

Repairkit for CR/CP 3 Reference F 00N 201 975

FLAG 80 1213

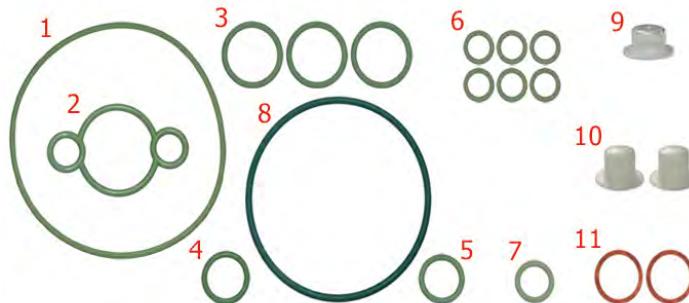

1. 81 0446
2. 81 0510
3. 81 0566
4. 81 0641
5. 81 0648
6. 81 0660
7. 81 0710
8. 81 0867
9. 83 0007
10. 83 0030
11. 84 0014

Repairkit for CR/CP 3 Reference F 00N 201 976

FLAG 80 1216

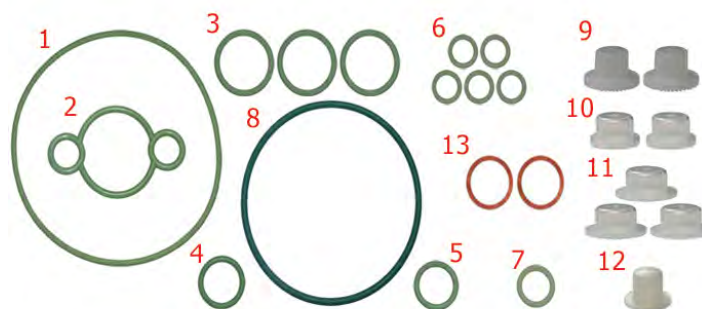

1. 81 0446
2. 81 0510
3. 81 0566
4. 81 0641
5. 81 0648
6. 81 0660
7. 81 0710
8. 81 0867
9. 83 0005
10. 83 0008
11. 83 0009
12. 83 0030
13. 84 0014

Repairkit for CR/CP 3 Reference F 00N 201 977

FLAG 80 1217

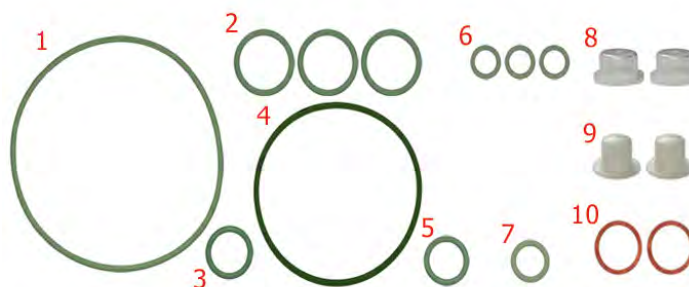

1. 81 0446
2. 81 0566
3. 81 0641
4. 81 0645
5. 81 0648
6. 81 0660
7. 81 0710
8. 83 0008
9. 83 0030
10. 84 0014

Bosch Common Rail

Repair Kit for CR/CP 3 Reference F 00N 201 978

FLAG 80 1218

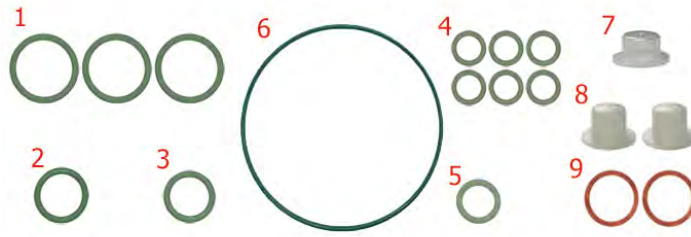

- 1. 81 0566
- 2. 81 0641
- 3. 81 0648
- 4. 81 0660
- 5. 81 0710
- 6. 81 0752
- 7. 83 0007
- 8. 83 0030
- 9. 84 0014

Repair Kit for CR/CP 3 Reference F 00N 201 979

FLAG 80 1219

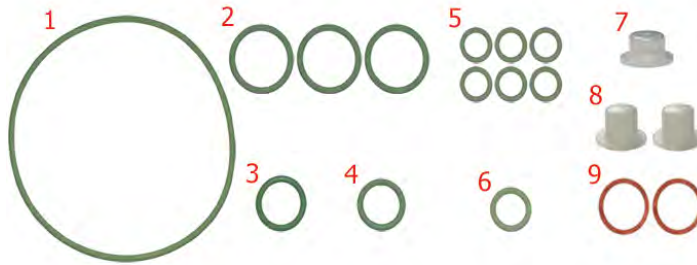

- 1. 81 0446
- 2. 81 0556
- 3. 81 0641
- 4. 81 0648
- 5. 81 0660
- 6. 81 0710
- 7. 83 0007
- 8. 83 0030
- 9. 84 0014

Repair Kit for CR/CP 3 Reference F 00N 201 973

FLAG 80 1207

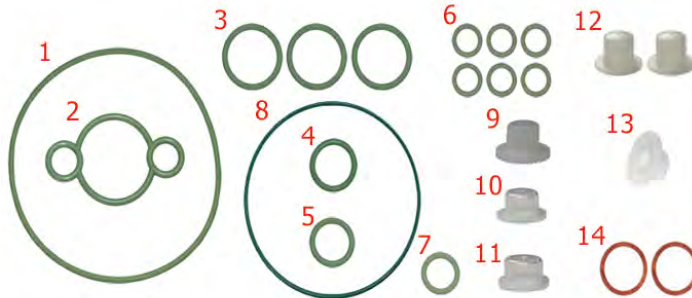

- 1. 81 0446
- 2. 81 0510
- 3. 81 0566
- 4. 81 0641
- 5. 81 0648
- 6. 81 0660
- 7. 81 0710
- 8. 81 0752
- 9. 83 0005
- 10. 83 0007
- 11. 83 0008
- 12. 83 0030
- 13. 83 0033
- 14. 84 0014

Repair Kit for CR/CP 3 Reference F 01M 100 278

FLAG 80 1122



- 1. 81 0340
- 2. 83 0644
- 3. 83 0650

Bosch Common Rail

High Pressure Pump CR/CP3S3/ FLAG 03 2075

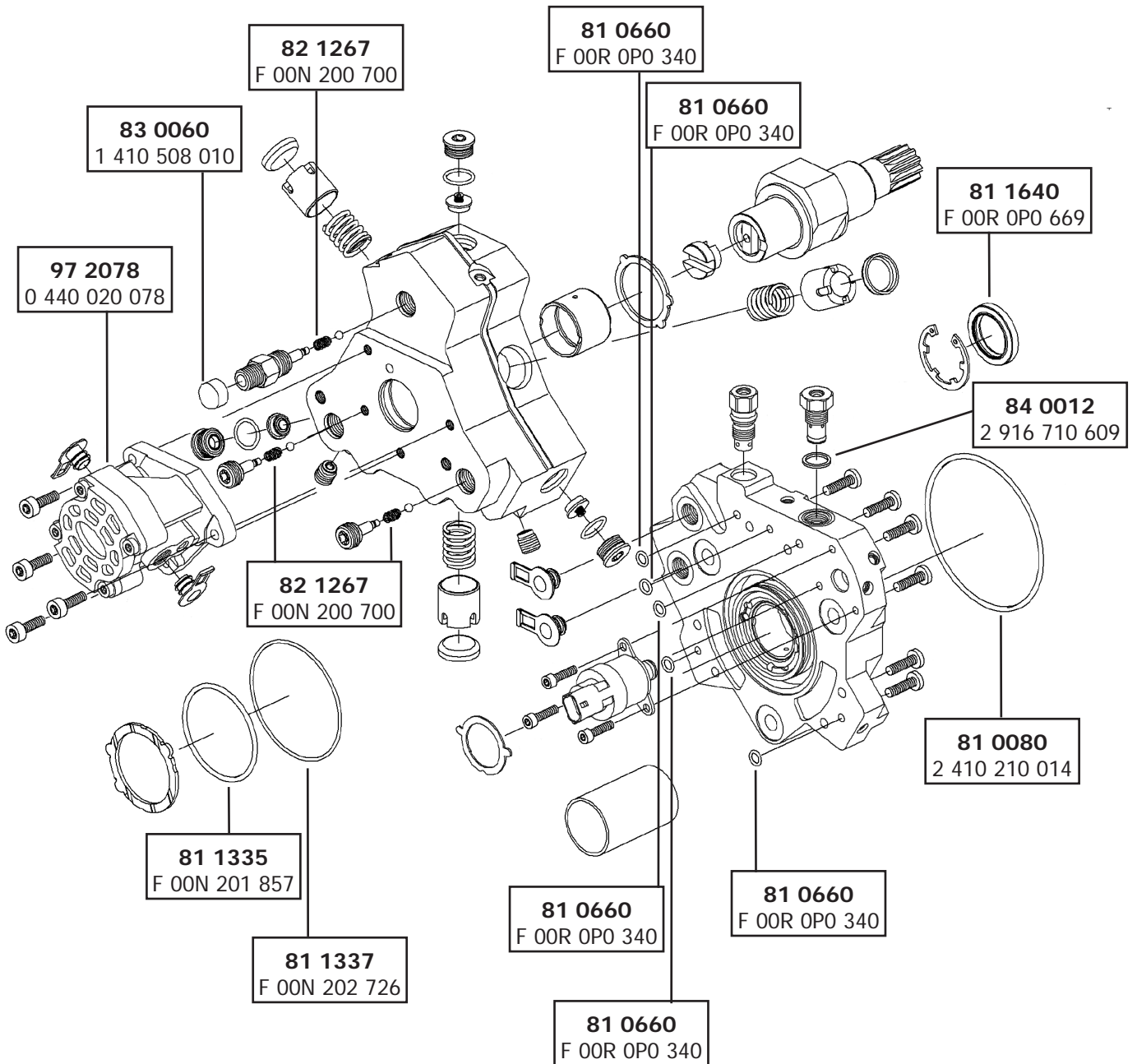

Bosch Common Rail

Repair Kit for CR/CP 3 MAN TGA

FLAG 80 2075



- 1. 81 0080
- 2. 81 1643
- 3. 81 1640
- 4. 84 0012
- 5. 84 0167
- 6. 81 0660
- 7. 81 1335
- 8. 81 1336
- 9. 81 1337
- 10. 82 1267
- 11. 82 0185
- 12. 81 0641
- 13. 81 0707
- 14. 81 1372
- 15. 81 0648

Gear Pump Reference 0 440 020 078 FP/ZP18/R1S

FLAG 97 2078



Gear Pump Reference 0 440 020 045 FP/ZP18/L1S

FLAG 97 2045



Gear Pump Reference 0 440 020 049 FP/ZP18/R1S

FLAG 97 2049



Prefilters with magnet



83 0750

Reference 34 F2154

Description

Prefilter with magnet and outlet flow valve. Tube Ø 6-8 mm. metallic



83 0751

Reference 34 F2155

Description

Prefilter with magnet and without outlet flow valve. Tube Ø 6-8 mm. metallic



83 0752

Reference 34 F2156

Description

Prefilter with magnet and outlet flow valve. Tube Ø 8-10 mm. nylonfilter



83 0753

Reference 34 F2157

Description

Prefilter with magnet and without outlet flow valve. Tube Ø 8-10 mm. nylonfilter



83 0754

Reference 34 F2158

Description

Prefilter with magnet and outlet flow valve. Tube Ø 12 mm. nylonfilter



83 0755

Reference 34 F2159

Description

Prefilter with magnet and without outlet flow valve. Tube Ø 12 mm. nylonfilter



83 0756

Reference 34 F2164

Description

Prefilter with magnet and outlet flow valve. Tube Ø 8 mm. nylonfilter „removable“



83 0757

Reference 34 F2165

Description

Prefilter with magnet and without outlet flow valve. Tube Ø 8 mm. nylonfilter „removable“

